

Item description/product images

**Description****Material:**

Housing, actuator and nut die-cast zinc.
Flat seal CR.

Version:

Housing and actuator trivalent passivated.
Nut electro zinc-plated.

Note:

Compression quarter-turn locks are primarily used for doors and housings that require a higher pressure force on the seal. For right or left use. The locking process is always clockwise. The quarter-turn lock can be installed pre-assembled. Vibration-resistant thanks to spring-loaded detent mechanism in the "locked" end position. Tested according to DIN EN 60068-2-64 (vibration) and DIN EN 60068-2-27 (shock), test standard 61373. Vibration-proof as per the requirements for rail applications category 1, class B (=highest requirement).

Water and dustproof as per IP65.

Accessory:

Key 05586.
Tongue for steel quarter-turn lock without stop 05570

Drawing reference:

Actuation:

- a) square 8 mm
- b) double lug 3 mm
- c) double lug 5 mm
- d) triangle 8 mm

Drawings

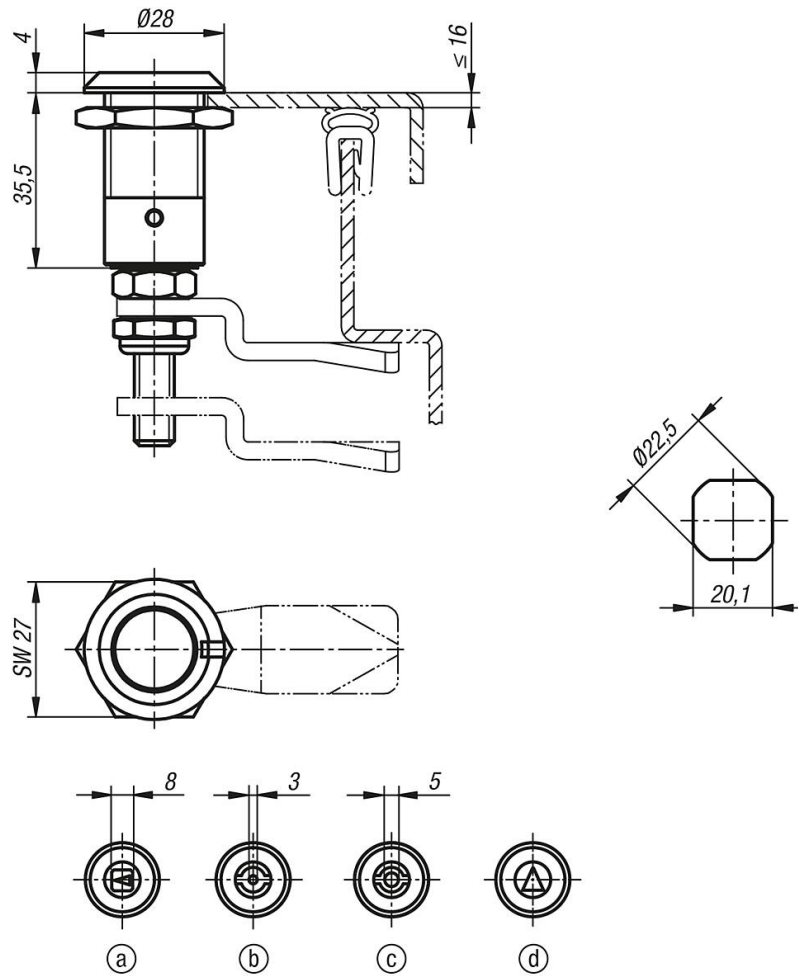

Overview of items

Order No.	Actuation
05575-18351	square 8 mm
05575-43351	double lug 3 mm
05575-45351	double lug 5 mm
05575-88351	triangle 8 mm