

Technical Information

Quarter-turn latches 03192-10 and clamping pins 03192-25

1. Application:

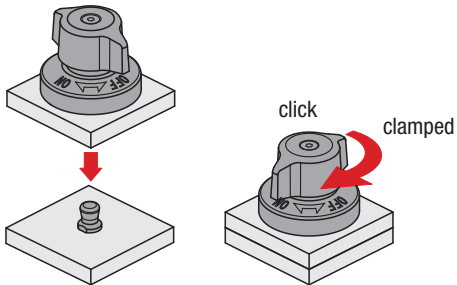

Check that the rotary knob is in the "OFF" position.
Set the quarter-turn latch over the clamping pin and turn the rotary knob to the "ON" position.
When fully clamped, a click sound is heard.

2. Function:

Four balls hold the clamping pin and clamp the plates together.

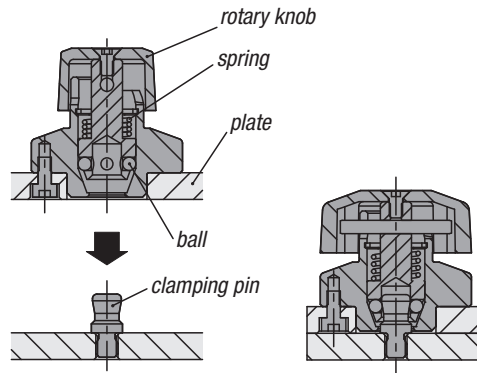

Production tolerances:

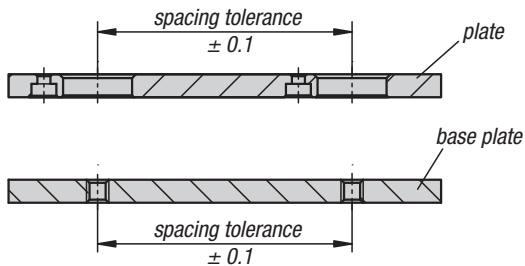

Repeat accuracy:

A higher repeat accuracy can be achieved with the aid of additional locating pins (not supplied).

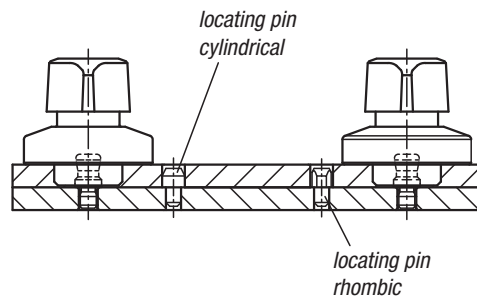

Application examples:

Replacement of the plates

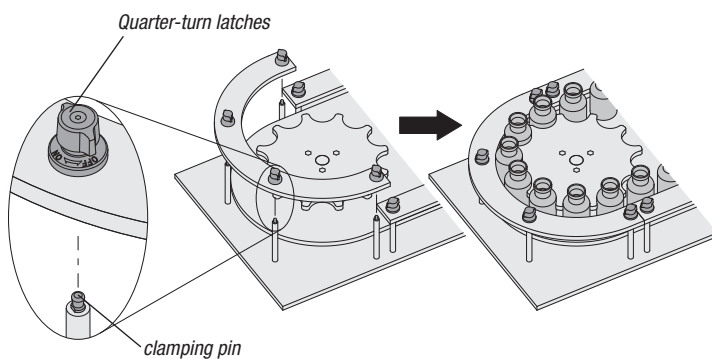

Lifting the suction pads

