

## Item description/product images

**Description****Version:**

Bright.

**Note:**

For holding small parts on measurement and control plates.

**Accessory:**

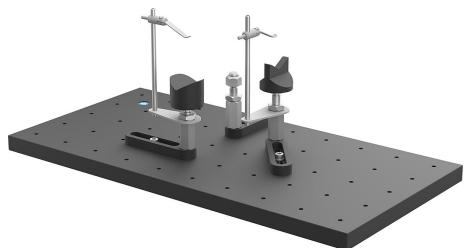
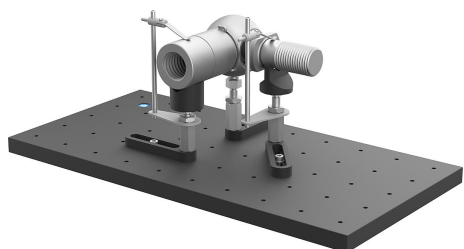
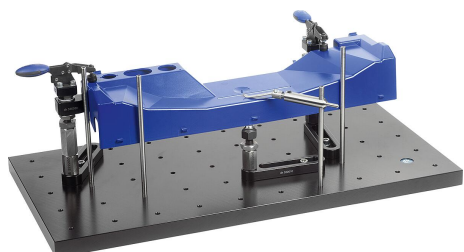
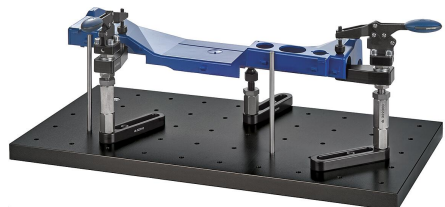
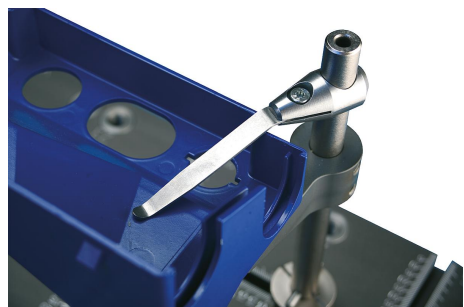

Columns, stainless steel for spring fingers 33262.



## Item description/product images

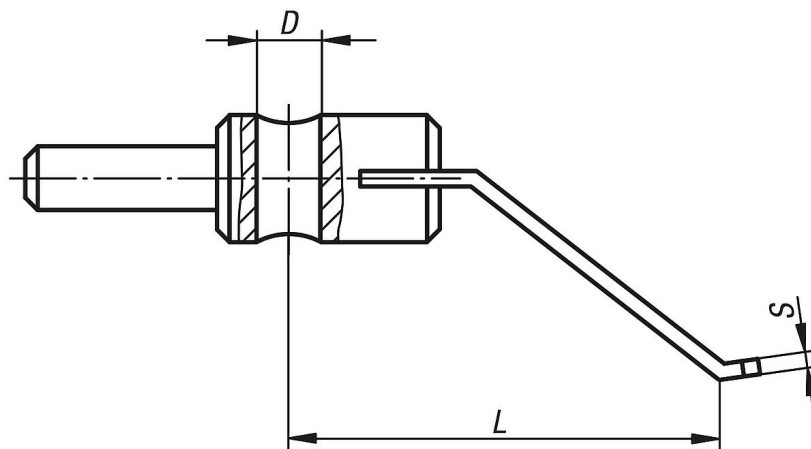

## Drawings

Spring finger, flat Spring finger with fork Spring finger, round wire 

## Overview of items

Order No.	Version	D	L	S
33260-10403004	flat	4	30	0,4
33260-10403008	flat	4	30	0,8
33260-10605010	flat	6	50	1
33260-10607510	flat	6	75	1
33260-11207510	flat	12	75	1
33260-11209510	flat	12	95	1
33260-21207515	fork	12	75	1,5
33260-21209515	fork	12	95	1,5
33260-30404011	round	4	40	1,1
33260-30406011	round	4	60	1,1
33260-31208025	round	12	80	2,5
33260-31208030	round	12	80	3

