

Item description/product images



Description

Material:
Steel.

Version:
Sleeve blue electro zinc-plated.
Spring pins black oxidised.

Note:
The tapped hole in both ends of the spring pin allow various inserts to be attached e.g. prisms, thrust pins, self-aligning pads, knobs, grips etc.

Assembly:
LOCTITE threadlocker 97990-243... is recommended for gluing the threaded sleeve in position.

Application:

As push plunger:
The spring force pushes the object.

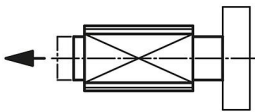

As pull plunger:
The spring force pulls the object.

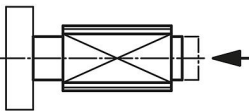

As push-pull plunger:
In this case the internal pin has a fixed position.
The threaded sleeve acts as carrier.
The spring force pushes or pulls the object in both directions.

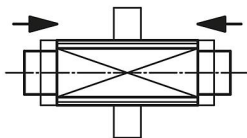

push-pull plunger

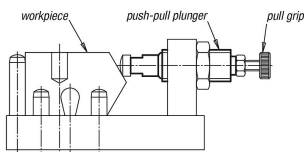

pull plunger as lock

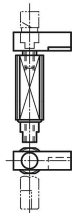

push-pull plunger as carrier

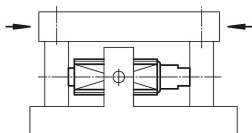

Drawings

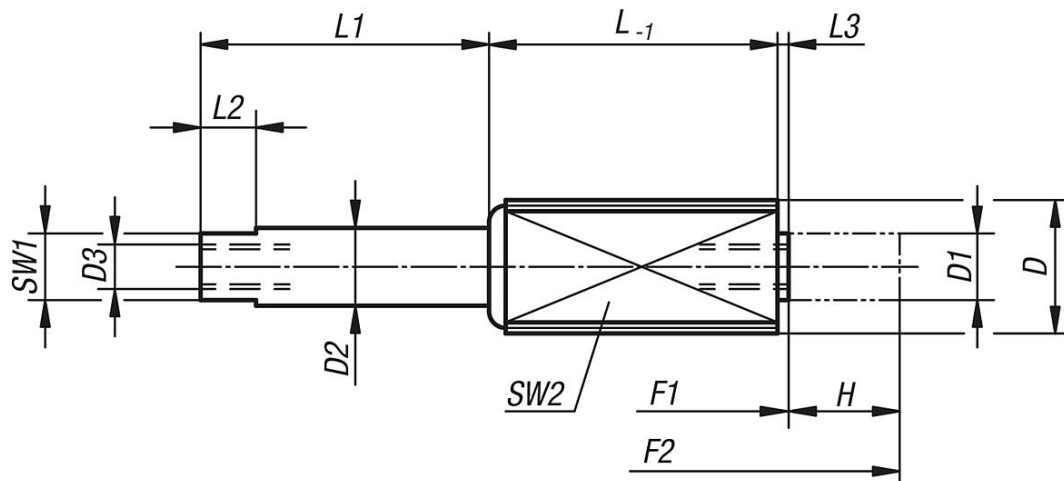

Overview of items

Order No.	D	D1	D2	D3	H	L	L1	L2	L3	SW1	SW2 square	Spring force initial pressure F1 approx. N	Spring force final pressure F2 approx. N
03338-1202004	M12	6	7	M4x8	3,5	11	4,5	5	1	6	10	5	20
03338-1202006	M12	6	7	M4x8	6	18,5	7	5	1	6	10	5	20
03338-1202010	M12	6	7	M4x8	10	26	11	5	1	6	10	5	20
03338-1206003	M12	6	7	M4x8	3	11	4,5	5	1	6	10	12	40
03338-1206005	M12	6	7	M4x8	5	18,5	7	5	1	6	10	12	40
03338-1206008	M12	6	7	M4x8	8	26	11	5	1	6	10	12	40
03338-1212503	M12	6	7	M4x8	3	11	4,5	5	1	6	10	20	100
03338-1212505	M12	6	7	M4x8	5	18,5	7	5	1	6	10	20	100
03338-1212508	M12	6	7	M4x8	8	26	11	5	1	6	10	20	100
03338-1815004	M18x1,5	10	11	M6x12	4	17	6	6	2,5	9	16	50	150
03338-1815007	M18x1,5	10	11	M6x12	7	29,5	11,5	6	2,5	9	16	50	150
03338-1815013	M18x1,5	10	11	M6x12	12,5	45,5	16	6	2,5	9	16	50	150